

HAVE TAX REFORMS AFFECTED INVESTMENT?

Jason G. Cummins

Columbia University

Kevin A. Hassett

Board of Governors of the Federal Reserve System

R. Glenn Hubbard

Columbia University and NBER

EXECUTIVE SUMMARY

We improve upon existing approaches used to estimate investment models by exploiting tax reforms as "natural experiments." We find that tax policy has an economically important effect through the user cost of capital on firms' equipment investment following major tax reforms enacted in 1962, 1971, 1981, and 1986. This effect is most pronounced for firms not in tax loss positions and, thus, more likely to face statutory tax rates and investment incentives. We also demonstrate that tax-induced variation in the user cost of capital across equipment asset classes is negatively related to asset-specific investment forecast errors following

We thank David Prince for research assistance, and Kristen Willard and Jim Poterba for helpful comments and suggestions. Cummins thanks the Center for International Business Education, the Center for Law and Economic Studies, and the Chazen Institute for financial support, and the Board of Governors of the Federal Reserve System for their hospitality during an internship. Hubbard acknowledges support from a grant from the John M. Olin Foundation to the Center for the Study of the Economy and the State of the University of Chicago and from the Federal Reserve Bank of New York. The views expressed here are those of the authors and do not necessarily reflect those of the Board of Governors of the Federal Reserve System.

major tax reforms, suggesting that ex ante knowledge of an impending tax reform can improve forecasts of investment.

1. INTRODUCTION

Economists and policy makers have long been interested in the effects of major changes in tax policy on the level and composition of business fixed investment. Indeed, many administrations have relied on investment tax policy as a tool for fiscal stimulus throughout the postwar period. Following in this tradition, President Clinton included an investment tax credit as an important component of his first tax proposal.

An informed policy debate requires estimates of the effectiveness of investment tax incentives. Providing participants in the tax policy process with estimates of the responsiveness of investment to changes in tax parameters is, however, a difficult task for two reasons. First, there is considerable debate over the "right" model of investment, complicating the definition of the theoretical link between tax parameters and the fundamental determinants of investment (e.g., the user cost of capital, tax adjusted q , internal funds, etc.). Second, much of the existing empirical literature is inconclusive (see, e.g., the survey in Chirinko, 1993).

In two papers (Cummins, Hassett, and Hubbard, 1994a,b), we investigate potential econometric problems that might have plagued the past literature. Employing techniques designed to overcome key confounding influences, we find that the familiar neoclassical model of investment—in which investment responds to changes in the net return to investing, subject to convex costs of adjusting the capital stock—describes the responses of business investment to changes in tax policy quite well. The key feature separating our work from much of the literature is that, in the past, researchers have relied upon time-series variation in investment incentives to identify investment models. This approach is appropriate only if that time-series variation in investment incentives is exogenous to aggregate investment patterns. A brief inspection of the historical experience suggests that this is not the case: Policy makers tend to introduce investment incentives when investment is perceived to be low and remove them when investment is perceived to be high (see Cummins, Hassett, and Hubbard, 1994a).

In our earlier work, we improve upon existing approaches for estimating these models by using the cross-sectional implications of *tax reforms* to identify exogenous shocks to firms' investment conditions. Major tax reforms offer "natural experiments" for evaluating the responsiveness of investment to fundamentals affecting the net return to investment because all assets are not equal in the eyes of the tax authority. Therefore,

the effects of tax p
purchase; tax refor
firms purchasing ra
slowly depreciating
exogenous, that is,
Applying our app
large effect on inv
different specificati
Cummins, Hassett
effects can be foun

In this paper, w
ment, and extend
for the possibility
ment incentives by
sis.¹ Our earlier an
access to tax benef
carrying forward t
some point in the
spond much less to
as they are earned
important addition
ness of our estima
ment to shifts in ta
implied forecasts s
impact of past ta
several ways; in a
parameter estimat
reforms across diff

The paper is or
through which ch
capital for fixed in
ing these effects. I
intend to study. In
in Cummins, Hass
methodology used
the tax code, in pa
tion 6, we use the
changes in outlays
the major U.S. p

¹ See, e.g., the disc
Altshuler and Auerbac

the effects of tax policy on firms depend upon the types of assets they purchase; tax reform will produce different investment incentives for firms purchasing rapidly depreciating machinery and firms investing in slowly depreciating property. We argue that this variation is likely to be exogenous, that is, not depending upon the current level of investment. Applying our approach, we find that tax policy has a significant and large effect on investment. We find very similar effects across many different specifications, over many different tax "experiments," and, in Cummins, Hassett, and Hubbard (1994b), we find that similar large tax effects can be found for many other countries.

In this paper, we focus on investment in producers' durable equipment, and extend our earlier work in several directions. First, we allow for the possibility that firms do not face statutory tax rates and investment incentives by incorporating tax loss carryforwards into our analysis.¹ Our earlier analysis assumed that all firms in our sample had equal access to tax benefits. This is, of course, a simplification. Firms who are carrying forward tax losses may not claim a credit earned today until some point in the future. One might argue that these firms should respond much less to tax incentives than firms that are able to claim credits as they are earned. We believe that identification of this effect is an important additional test of our methods. Second, we explore the usefulness of our estimates for predicting the response of aggregate investment to shifts in tax policy. If our estimates are "structural," the models' implied forecasts should provide a reasonable *ex ante* prediction of the impact of past tax reforms on investment. We explore this point in several ways; in addition to forecasting aggregate values, we use our parameter estimates to predict out-of-sample compositional effects of reforms across different types of capital goods.

The paper is organized as follows. Section 2 reviews the channels through which changes in tax parameters influence the user cost of capital for fixed investment, and summarizes our technique for estimating these effects. In Section 3, we briefly summarize the tax reforms we intend to study. In Section 4, we present the estimation results obtained in Cummins, Hassett, and Hubbard (1994a). In Section 5, we extend the methodology used in Section 4 to account for additional complications of the tax code, in particular the existence of tax-loss asymmetries. In Section 6, we use the estimates from the previous section to forecast the changes in outlays in categories of investment goods following each of the major U.S. postwar tax reforms. We compare these forecasts to

¹ See, e.g., the discussions in Auerbach (1986), Auerbach and Poterba (1987), and Altshuler and Auerbach (1990).

actual investment outcomes in order to construct evidence of the effects of the major policy changes. Section 7 concludes.

2. MODELING THE RESPONSIVENESS OF INVESTMENT TO TAX CHANGES

To summarize effects of tax parameters in investment decisions, we use the familiar user cost of capital model.² In this formulation, the firm equates the marginal product of capital and the shadow price of capital, c :

$$C_{i,t} = \frac{p_{i,t}(1 - \Gamma_{i,t})(\rho_{i,t} + \delta_{i,t} - \left(\frac{\Delta(p_{i,t+1}(1 - \Gamma_{i,t+1}))}{p_{i,t}(1 - \Gamma_{i,t})} \right))}{1 - \tau_t}, \quad (1)$$

where i and t are the firm and time indices, respectively; p is the price of capital goods relative to output; ρ is the firm's real required rate of return; δ is the rate of economic depreciation; Δ is the difference operator; τ is the corporate tax rate; and Γ is the present value of tax savings from depreciation allowances and other investment incentives. For example, with an investment tax credit at rate k :

$$\Gamma_{i,t} = k_{i,t} - \sum_{s=t}^{\infty} (1 + r_s + \pi_s^e)^{-s} \tau_s D_{i,s}(s - t), \quad (2)$$

where r is the default risk free real rate of interest, π^e is expected inflation, and $D_{i,s}(a)$ is the depreciation allowance permitted an asset of age a .

The definition of the user cost of capital in Equation (1) makes clear that permanent changes in tax parameters can have a significant effect on the user cost of capital. We now outline an approach to estimate the responsiveness of investment to the user cost of capital. Following our (1994a) paper, we begin by considering the following general model of investment:

$$\frac{I_{i,t}}{K_{i,t-1}} = E_{i,t-1}(S_{i,t})\gamma + \epsilon_{i,t}. \quad (3)$$

² The user cost approach follows the seminal contributions of Jorgenson (1963) and Hall and Jorgenson (1967). The setup we use follows a generalization of their work that includes costs of adjustment; see, for example, Auerbach (1989) and Abel (1990).

where I and K denote investment and capital, respectively, in an underlying structural model; $E_{i,t-1}$ is the expectation operator based on information available at time $t - 1$; $\epsilon_{i,t}$ is the firm's investment optimization error by firm i at time t .

We treat expected S as a random variable. In principle, we may write

$$\frac{I_{i,t}}{K_{i,t-1}} = S_{i,t}\gamma + \epsilon_{i,t}.$$

Given Equation (4), the dependent variable is available using information available at time $t - 1$.

$$\frac{I_{i,t}}{K_{i,t-1}} - P_{i,t-1} \frac{I_{i,t-1}}{K_{i,t-1}} = (S_{i,t} - P_{i,t-1} S_{i,t-1})\gamma + \epsilon_{i,t} - P_{i,t-1} \epsilon_{i,t-1}$$

where P is a projection operator based on the firm's information set.

To construct an estimator of γ near a tax reform we control for changes in the nontax elements. To do this we use a second-stage regression, where each nontax component is expected to be constant in the previous period. For example, in 1986, we impose the assumption that the 1987 year-end depreciation allowance was the year-end 1986 allowance. In other words, we sidestep year-to-year changes in the example of the 1986 tax reform. This projection for each firm through the first postreform year is given by

Returning to the model, we adjust for adjustment costs to the firm's investment depends on the user cost of capital (see, e.g., Jorgenson and Hall). The rule is given by:

$$\frac{I_{i,t}}{K_{i,t-1}} = \mu_i + \xi E_{i,t-1} \left[\sum_{s=t}^{\infty} \omega_s \right]$$

where I and K denote investment and the capital stock, respectively; S is an underlying structural variable (e.g., the user cost of capital) or set of variables; $E_{i,t-1}$ is the expectations operator conditional on information available at time $t - 1$; and ϵ is a white noise error term reflecting optimization error by firms.

We treat expected S as observable following major tax reforms, so that, in principle, we may rewrite Equation (3) during those periods as:

$$\frac{I_{i,t}}{K_{i,t-1}} = S_{i,t}\gamma + \epsilon_{i,t} \quad (4)$$

Given Equation (4), the deviation of (I/K) from the value linearly predictable using information available at time $t - 1$ is:

$$\frac{I_{i,t}}{K_{i,t-1}} - P_{i,t-1} \frac{I_{i,t}}{K_{i,t-1}} = (S_{i,t} - P_{i,t-1}S_{i,t}) \gamma + \epsilon_{i,t} \quad (5)$$

where P is a projection operator constructed from a nontax subset of the firm's information set.

To construct an estimator, we make the identifying assumption that near a tax reform we can observe expected S , in principle including the nontax elements. To avoid introducing simultaneity bias into the second-stage regression, we assume that the firm's expected value for each nontax component of S equals its value at the beginning of the previous period. For example, for the case of the Tax Reform Act of 1986, we impose the assumption that the expected interest rate in 1987 was the year-end rate for 1985. To avoid confounding timing issues, we sidestep years in which tax changes occurred. Returning to the example of the 1986 Act, we estimate a first-stage projection equation for each firm through 1985, and then construct forecasts for 1987, the first postreform year.

Returning to the model in Equation (3), and incorporating quadratic adjustment costs to the firm's profit function, one can show that current investment depends on current and future expected values of the user cost of capital (see, e.g., Auerbach, 1989). That is, a firm's investment rule is given by:

$$\frac{I_{i,t}}{K_{i,t-1}} = \mu_i + \xi E_{i,t-1} \left[\sum_{s=t}^{\infty} \omega_i^s c_{i,s} \right] + \epsilon_{i,t} \quad (6)$$

cost of the asset before computing depreciation for tax purposes, effectively doubling the benefit of the ITC. The investment tax credit was then suspended in 1966. The Revenue and Expenditure Control Act of 1968 introduced a corporate income tax surcharge of 10 percent. The investment tax credit was reinstated in 1969. In 1970, the surcharge was reduced to 2.5 percent, and the investment tax credit was eliminated. The surcharge was removed for 1971. For 1972, the investment tax credit was reintroduced, and the first major liberalization of depreciation allowances was enacted. Asset lives were shortened through the asset depreciation range (ADR) system. If one takes these changes together, the effective credit rate was generally about 7 percent. The credit was temporarily increased to 10 percent in 1975. In 1979, the corporate tax rate was lowered from 48 percent to 46 percent, and the temporary increase in the investment tax credit was made permanent. The Economic Recovery and Tax Act of 1981 provided the second major liberalization of depreciation allowances. It replaced the numerous asset depreciation classes with three capital recovery classes. Light equipment was written off over three years, other equipment over five years, and structures over 15 years. The reduction was modified one year later by repealing the accelerations in the writeoff that were to occur in 1985 and 1986, and instituted a basis adjustment of 50 percent for the credit. As a result, the effective rate was generally about 8 percent. The Tax Reform Act of 1986 reduced the corporate tax rate to 40 percent in 1987 and to 34 percent in 1988, and eliminated the investment tax credit.

Our specific criteria for identifying "major reforms" were: (1) the value of the tax wedge in the user cost of capital (that is, $(1 - \Gamma)$) must have changed in absolute value by at least 10 percent, (2) no tax shift of that magnitude occurred in either the preceding or succeeding year, and (3) the reforms were unanticipated in the year prior to the reform. Using these criteria, we identified as major tax reforms the set of tax changes occurring in legislation enacted in 1962, 1971, 1981, and 1986.

We illustrate the effects of tax reforms on investment incentives in Figures 1^a and 2. The time-series variation in investment incentives is evident in Figure 1, which plots a representative tax wedge, $(1 - \Gamma)$, for equipment over the period from 1953 to 1989.⁴ Figure 2 introduces the added dimension of *cross-sectional* variation in the tax wedge across asset classes, plotting $(1 - \Gamma)$ by equipment asset class (using the 22 equipment classes measured by the Commerce Department's Bureau of Economic Analysis, BEA) in each period. As the changing distribution of tax incentives in Figure 2 illustrates, tax reforms are associated not only

⁴ The tax wedge shown is for special industrial machinery.

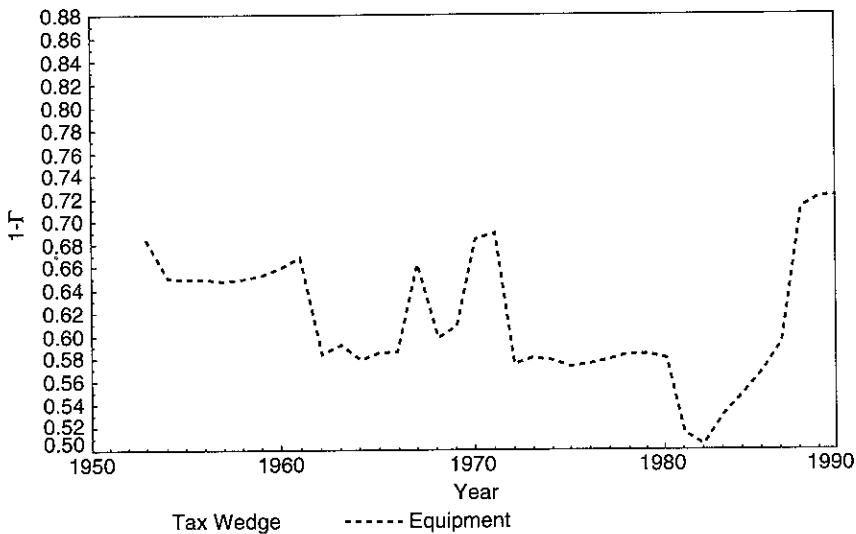

FIGURE 1. After-Tax Cost of \$1 of Investment: Equipment.

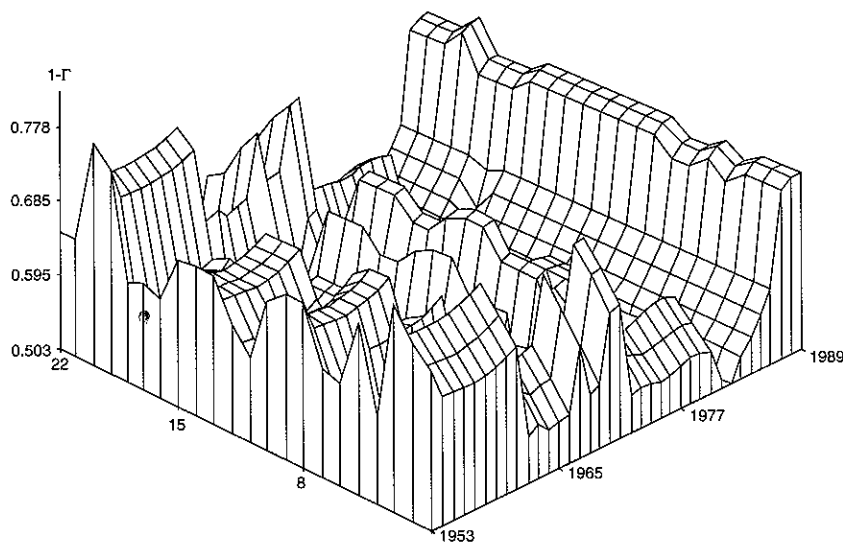

FIGURE 2. After-Tax Cost of \$1 of Equipment Investment: BEA Assets 1-22, 1953-1989.

with increases or de
but also with shift
equipment assets.
forms that we expl

4. RESULTS FR

Estimates of the us
on equipment inve
1. The first row of
major tax reform in
user cost of capital
the mean for the u
approximately equ
percent decrease in
investment-capital
our base-case estim
reforms. In each ca
cost of capital is n
elasticity of investm
-0.75.⁷

5. FIRM TAX S

In the previous sec
investment could cl
investment is being
that carry forward

⁵ The dataset and proce

⁶ These estimated coeff
beginning-of-period cap

⁷ If one assumes an ave
cost of 0.25, the implied
cents. This estimated a
earlier empirical studie

⁸ The potential empirica
Cordes and Sheffrin (19
of tax-loss carryforward
and effects of firm decis
1986; Auerbach and Pu
forwards in Compustat
income tax returns, and
the incidence of tax loss

with increases or decreases in the *average* level of investment incentives, but also with shifts in the *distribution* of investment incentives across equipment assets. It is this cross-sectional shift in response to tax reforms that we exploit in our empirical work.

4. RESULTS FROM EARLIER WORK

Estimates of the user cost model (Equation [5]) based on firm-level data on equipment investment using firm-level data⁵ are presented in Table 1. The first row of Table 1 reports results for the year following the first major tax reform in our sample, 1962.⁶ The estimated coefficient on the user cost of capital (-0.605) is negative and statistically significant. Since the mean for the user cost and the ratio of investment to capital are approximately equal in our sample, this estimate implies that a 10-percent decrease in the user cost of capital will increase the equipment investment-capital ratio by about 6 percent. The next three rows report our base-case estimates for the years following subsequent major tax reforms. In each case we find very similar results: The coefficient on the cost of capital is negative and statistically significant, and implies an elasticity of investment with respect to the user cost between -0.6 and -0.75 .⁷

5. FIRM TAX STATUS AND THE USER COST

In the previous section, we assumed that the firm choosing the level of investment could claim the tax benefits of investment at the time that the investment is being made. This assumption is clearly inaccurate for firms that carry forward tax losses.⁸ For these firms, any tax benefits accrued

⁵ The dataset and procedures for constructing variables are summarized in the Appendix.

⁶ These estimated coefficients do not change qualitatively if lagged cash flow (relative to beginning-of-period capital stock) is added as an explanatory variable.

⁷ If one assumes an average value of the user cost coefficient of -0.7 and an average user cost of 0.25, the implied cost of adjustment per dollar of equipment investment is about 30 cents. This estimated adjustment cost is significantly lower than that estimated in many earlier empirical studies (see, e.g., Summers, 1981; Fazzari, Hubbard, and Petersen, 1988).

⁸ The potential empirical significance of firms in tax loss positions has been established by Cordes and Sheffrin (1983) and Auerbach and Poterba (1987). Modeling directly the effects of tax-loss carryforwards is difficult, however, as assumptions about the earnings process and effects of firm decisions on carryforward positions are required (see, e.g., Auerbach, 1986; Auerbach and Poterba, 1987). Moreover, accounting measures of tax-loss carryforwards in Compustat do not correspond precisely to measures in federal corporate income tax returns, and the incidence of tax losses in Compustat may not summarize well the incidence of tax losses for firms generally.

TABLE 1.
Estimates of User Cost Model, Major Tax Reform Years

Year	Constant	User cost of capital	\bar{R}^2
1963 (N = 107)	-0.078 (2.72)	-0.605 (4.21)	0.145
1973 (N = 267)	0.024 (1.32)	-0.546 (4.00)	0.057
1982 (N = 469)	-0.047 (5.06)	-0.757 (3.89)	0.032
1987 (N = 549)	0.013 (.736)	-0.747 (3.32)	0.022

Notes: *t*-statistics are reported in parentheses below the point estimates. The number of firms is reported in parentheses under each year. Estimates are based on the analysis of Compustat data in Cummins, Hassett, and Hubbard (1994a).

today just add to the stock of tax benefits being carried forward. The value of, say, an investment tax credit depends upon how far into the future the firm expects to have to wait before claiming the credit accrued in the current period. Strictly speaking, then, the estimated effect of the user cost of capital on investment—using the technique described earlier and grouping we have used in our earlier work—may be biased downward, since we ignored in previous work the important heterogeneity introduced by differences in tax status. In this section, we extend our previous work, testing for important differences in the responsiveness to investment fundamentals between firms that are in a tax loss position (and currently paying no federal corporate income taxes) and those that are not. We view this exercise as an important additional test of the validity of our results.

Table 2 reports the results of this experiment for each of the major tax reforms described in Section 4 except that for 1962.⁹ (We do not report results for this reform, since we had almost no firms in our sample in a tax loss position at that time.) We present the estimated effect of the user cost

These concerns, while important, are not serious for the exercise presented here. We are using the tax loss carryforward status only as a signal of a firm's ability to claim tax credits: Sample splitting based upon prior information does not require a "perfect" measure of the existing stock of tax losses. Our split might not be informative if firms enter and exit tax loss status frequently. Studying the period from 1968 through 1984, Auerbach and Poterba (1987) find significant persistence in tax loss status, however. If our measure of tax loss status does not accurately depict the true conditions for the firms in our sample, then we should expect to see little difference between our sets of firms in the responsiveness of investment to the user cost of capital.

⁹ As with Table 1, these estimated coefficients are not qualitatively different when lagged cash flow (relative to beginning-of-period capital stock) is added as a regressor.

Estimates of User Cost

Year	No tax loss carryforward	
	Constant	User cost of capital
1973	-0.039 (-3.28)	-0.65 (-6.21)
1982	-0.059 (-2.63)	-1.02 (-2.84)
1987	0.020 (1.04)	-1.71 (-3.61)

Note: *t*-statistics are reported in parentheses below the point estimates. The number of firms in each category is reported in parentheses below the point estimates. Estimates are based on Cummins, Hassett, and Hubbard (1994a).

of capital on investment fundamentals in the year prior to our period. The coefficients presented in Table 2 are for a set of firms that can claim a tax loss in the estimated coefficient of capital on investment. (The estimated user cost coefficient for firms with tax loss carryforwards, respectively.) In the case of tax loss carryforwards, the estimated user cost of capital is -0.303, and 0.698, respectively. The estimated coefficients is significant if the responsiveness makes sense if they can claim any tax benefits. We predict the effects of changes in the user cost of capital explicitly for the firms in a tax loss position. Among the firms in a tax loss position, the value of the) elasticity of investment to the user cost of capital may be

¹⁰ We cannot reject the hypothesis that the responsiveness to the user cost of capital without tax loss carryforwards is the same as for the former group of firms are very

¹¹ An important additional consideration is the minimum tax (AMT). Firms with tax loss carryforwards and, thus, may respond to changes in the user cost of capital may be of increasing importance in the investigation of this issue is

TABLE 2.
Estimates of User Cost Model By Tax Loss Status, Major Tax Reform
Years

Year	No tax loss carryforwards			Tax loss carryforwards		
	Constant	User cost of capital	\bar{R}^2	Constant	User cost of capital	\bar{R}^2
1973	-0.039 (-3.28)	-0.656 (-6.21)	0.131 (N = 247)	-0.005 (-0.110)	-0.266 (-1.43)	0.097 (N = 20)
1982	-0.059 (-2.63)	-1.02 (-2.84)	0.020 (N = 440)	-0.118 (-1.18)	-0.303 (-0.189)	0.010 (N = 29)
1987	0.020 (1.04)	-1.71 (-3.61)	0.024 (N = 495)	-0.082 (-1.60)	0.698 (0.529)	0.005 (N = 54)

Note: *t*-statistics are reported in parentheses below the point estimates. The number of firms in each category is reported in parentheses in each year. The estimation technique is discussed in the text and is based on Cummins, Hassett, and Hubbard (1994a).

of capital on investment for firms with and without tax loss carryforwards in the year prior to our period of estimation. The pattern of the estimated coefficients presented in Table 2 is intuitively appealing: Within the subset of firms that can claim any investment incentives in the current year, the estimated coefficient is larger than in our original sample. (The estimated user cost coefficients are -0.656 , -1.021 , and -1.70 , in the three reforms, respectively.) In addition, we find no evidence that firms with tax loss carryforwards respond to changes in the tax components of the user cost. In particular, the estimated user cost coefficients are -0.266 , -0.303 , and 0.698 , respectively, in the three reforms; none of these estimated coefficients is significantly different from zero. This lack of responsiveness makes sense if firms expect to have to wait many years before they can claim any tax benefits.¹⁰ Three results suggest that, in order to predict the effects of changes in investment tax policy, one will have to control explicitly for the percentage of firms that are expected to be in a tax loss position. Among those firms that are not, we find that the (absolute value of the) elasticity of the investment capital ratio with respect to the user cost of capital may even be larger than unity.¹¹ In addition, this split

¹⁰ We cannot reject the hypothesis that the coefficients are the same for firms with and without tax loss carryforwards. This is because the standard errors of the estimates for the former group of firms are very large.

¹¹ An important additional consideration that we do not address here is the alternative minimum tax (AMT). Firms on the AMT face significantly different marginal investment incentives and, thus, may respond differently than firms not on the AMT. This difference may be of increasing importance in the early 1990s. Unfortunately, data limitations make the investigation of this issue impossible in our current study.

provides additional evidence that adjustment costs may be much lower than previous work has suggested. Our largest estimated coefficients are consistent with adjustment costs roughly equal to 15 cents for each dollar of investment.

Finally, it is worth noting that the overall fit of our equations remains low. This suggests that there may be very important omitted variables (e.g., shocks to firms' demand). Our sensitivity analysis suggests that these omitted variables are uncorrelated with the cross-sectional variation in marginal tax rates; if they were not, our results would be sensitive to inclusion of other firm fundamentals. Thus, our estimates of the likely effects of taxes are not invalidated by the low \bar{R}^2 . On the other hand, investment is a highly volatile variable, and observation of tax effects after tax reforms may be difficult if many other things are changing at the same time. We return to this point in our forecasting discussion below.

6. OTHER AGGREGATE EVIDENCE

In this section, we explore further the plausibility of the substantial effects of tax reforms on investment documented in the previous section. The evidence suggests that forecasts of aggregate investment, adjusted to include tax effects, perform better than forecasts that exclude tax effects. We demonstrate this in an intuitive manner by using vector autoregressions to forecast investment for each of BEA's 22 classes of equipment investment in the year following a tax reform, and then compare the forecast errors for each of the assets to the changes in the user cost for that asset.¹² In Figures 3-6 (one for each major tax reform),¹³ we provide plots of these forecast errors constructed from models that exclude taxes against shocks to the user cost of capital for each of the 22 equipment asset classes tracked by the BEA. In addition, we draw a

¹² The VAR regressions are run separately for each asset, and, in addition, two autoregressive terms include lags of aggregate output and the six-month Treasury-bill rate. The capital stock data are from the BEA, and are described more fully in Cummins, Hassett, and Hubbard (1994a). For the 1962 experiment, we used only the AR(2) terms because of the very short pre-reform sample period, which reduced the degrees of freedom for the forecasting runs.

¹³ There is a difference between the years we report in the "asset experiments" (1962, 1973, 1981, and 1987) and those we report in the "firm" experiments (1963, 1973, 1982, and 1987). This is because the asset data are calculated on a calendar year basis, while the firm data are calculated on a fiscal-year basis. We have chosen the "experiment" year with this difference in the data definitions in mind. As a result, when a tax change occurs relatively early in a year, the asset data will show a response in that year. In contrast, firm data will report much of the change in the next fiscal year. Consider, for example, the Economic Recovery Tax Act of 1981. While the legislation passed on July 31, 1981, the 1982 fiscal year would capture most of the effect for most firms.

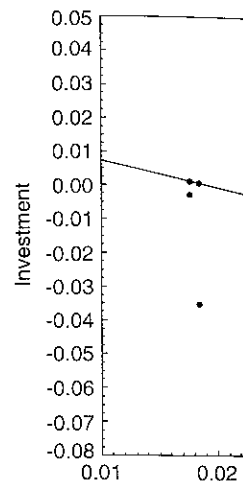

FIGURE 3. Cross-Sectional User Cost Forecast Error

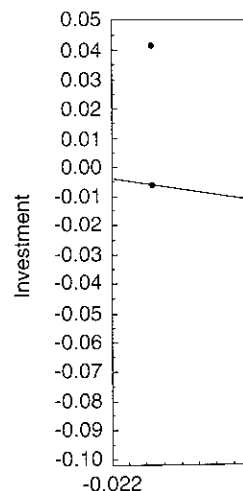

FIGURE 4. Cross-Sectional User Cost Forecast Error

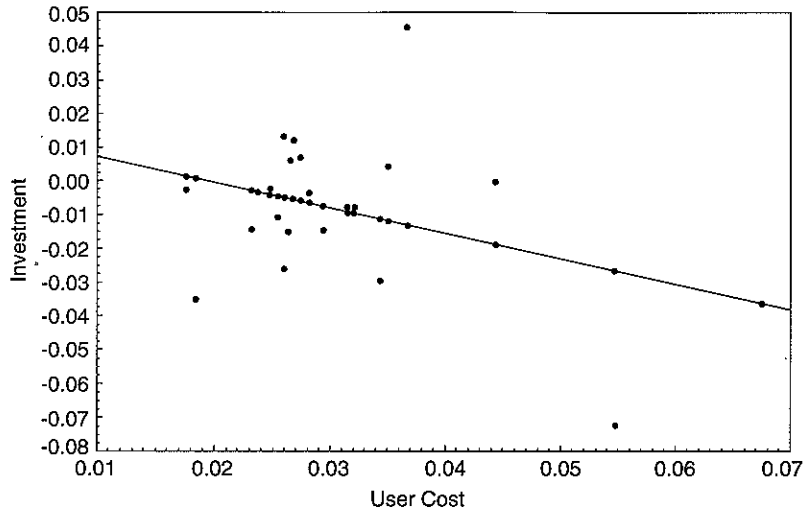

FIGURE 3. Cross-Sectional Relationship Between Investment and User Cost Forecast Errors: 1987.

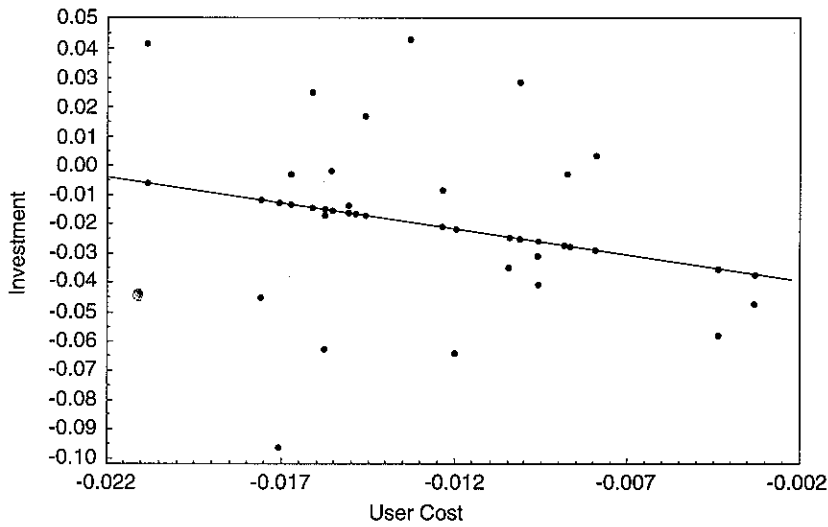

FIGURE 4. Cross-Sectional Relationship Between Investment and User Cost Forecast Errors: 1981.

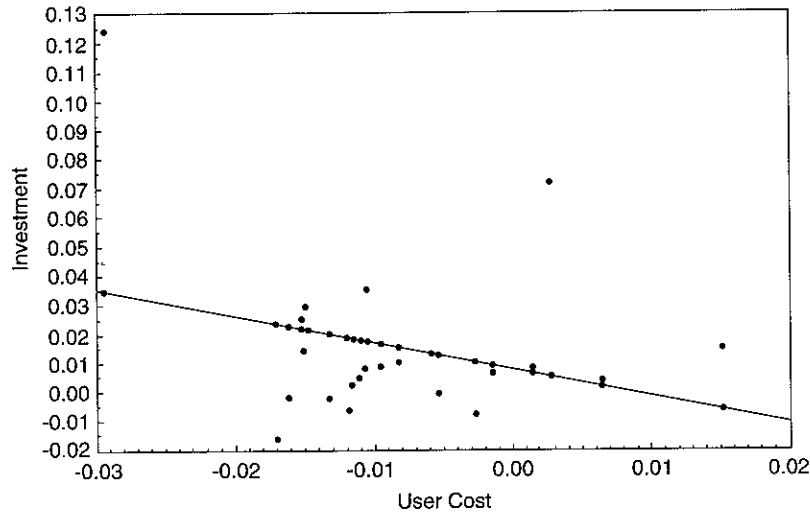

FIGURE 5. *Cross-Sectional Relationship Between Investment and User Cost Forecast Errors: 1973.*

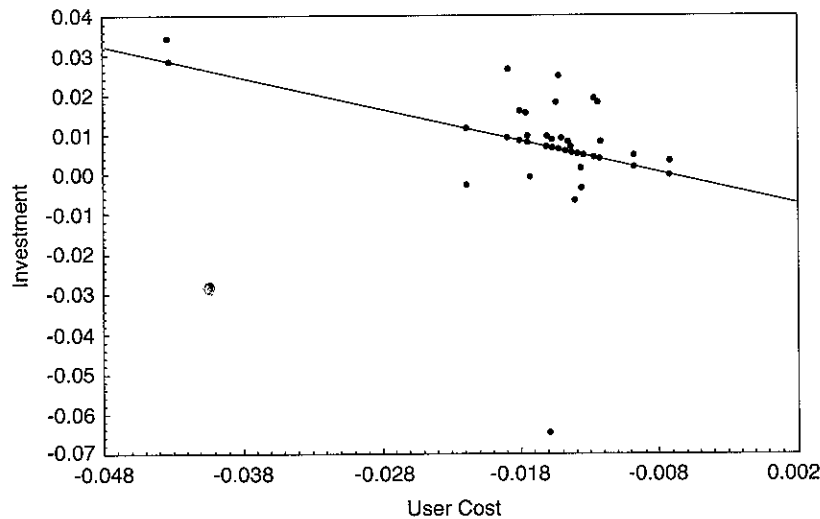

FIGURE 6. *Cross-Sectional Relationship Between Investment and User Cost Forecast Errors: 1962.*

regression line through the errors for investment shows that the errors for the user costs are not as large as suggested by our estimates.

These plots suggest a regression line in each of the charts. The strength of the correlation is similar, the correlation in 1983 were present—appears to be the strongest. In all cases, that prior knowledge of changes in asset investment. The movements of investment while the movements of investment are consistent with the predictions of the variation across assets is a surprise; taxes are not the same years.

Our tax results are to show that a change in the marginal tax rate that alters the marginal return to investment with changes in investment. That tax parameters are not constant, the impact of tax reform on investment. For example, the constant term in the average "year effect" is the average "year effect" of all other changes in investment. In our experiments, this year effect is important in magnitude during recessions, in the opposite direction of the year effect would have been forecast if the credit was enacted. This is the case for our sample period, the literature—estimated user cost effect of a tax reform on investment is 0.01.¹⁴ Over our sample period, the ratio is about 0.2, and the error of investment is roughly the same as the tax reform. While, all else

¹⁴ This calculation assumes that the tax reforms, if anticipated, can be implemented in the periods where the

regression line through the scatterplot. The idea is that the forecast errors for investment should be negatively correlated with the forecast errors for the user costs of capital if tax parameters are having the effects suggested by our estimates in Section 3.

These plots suggest a number of points. First, the downward-sloping line in each of the charts indicates a clear negative correlation, although the strength of the correlation varies somewhat across years. In particular, the correlation in 1981—a recession year wherein many other forces were present—appears to be weakest, whereas the correlation in 1987 is the strongest. In all cases, however, the pattern of the two errors suggest that prior knowledge of changes in tax parameters can improve forecasts of asset investment. The second important lesson from the charts is that, while the movements of investment for the individual series are consistent with the predictions of the neoclassical model, a significant amount of the variation across assets is not explained. This should come as no surprise; taxes are not the only thing changing, even in the tax reform years.

Our tax results are to some extent reassuring: A key fundamental variable that alters the marginal tradeoffs for investors is highly correlated with changes in investment. Our forecasting figures suggest, however, that tax parameters are only a piece of the puzzle, and predicting the impact of tax reform on investment remains a formidable task. Consider, for example, the constant terms in our estimated models. These capture the average "year effect" and are an indicator of the total effect on investment of all other changes in fundamentals in a given year. In almost all of our experiments, this year effect is very statistically significant and as important in magnitude as changes in tax policy. For tax reforms occurring during recessions, for example, the year effect may work in the opposite direction of the tax reform, that is, investment is lower than would have been forecast in the prior year, even though an investment tax credit was enacted. This simply reflects the fact that investment is volatile. For our sample period, using our "large"—compared with the past literature—estimated user cost coefficients, the mean absolute predicted effect of a tax reform on the ratio of investment to the capital stock is about 0.01.¹⁴ Over our sample period, the mean of the investment-to-capital ratio is about 0.2, and the standard deviation is 0.04. Thus, the standard error of investment is roughly four times as large as the typical effect of a tax reform. While, all else equal, our estimates provide a clue about the

¹⁴ This calculation assumes that tax reforms are unanticipated. The effects of temporary reforms, if anticipated, can be quite large, since they provide incentives to bunch investment in the periods where the best tax benefits are available.

responsiveness of investment to tax-induced changes in the user cost of capital, all else is seldom equal, and analysts should proceed cautiously when attempting to evaluate potential policy actions using our results.

7. CONCLUSIONS

In this paper, we find that tax policy had an economically important effect through the user cost of capital on firms' equipment investment following major tax reforms enacted in 1962, 1971, 1981, and 1986. This effect is most pronounced for firms not in tax loss positions and, thus, more likely to face statutory tax rates and investment incentives. We also demonstrate that tax-induced variation in the user cost of capital across equipment asset classes is negatively related to asset-specific investment forecast errors following major tax reforms. This correlation is consistent with the standard neoclassical model, and suggests that *ex ante* knowledge of an impending tax reform can improve forecasts of investment.

APPENDIX: FIRM-LEVEL DATA AND ESTIMATION

The data set used to generate the results in Tables 1 and 2 is a 36-year (1953–1988) unbalanced panel of firms from the Compustat Industrial data base. Compustat data are reported in 20-year waves, so the 1989 file is combined with the 1973 file to make a continuous panel. Variable definitions are standard except for our measure of the user cost of capital. We exploit additional firm level information in Compustat to construct more precise estimates of the user cost of capital and to add to the cross-sectional variation in the panels.

The variables used are defined as follows: Gross investment is the sum of the change in the net stock of property, plant and equipment and in depreciation. Gross equipment investment (used in estimating the user cost of capital model) is the change in the net stock of machinery and equipment grossed up by the estimated firm-specific rate of equipment depreciation (estimated as in Cummins, Hassett, and Hubbard, 1994a). The investment variables are divided by the values of their own beginning-of-period capital stocks. Where appropriate, variables are deflated by the implicit price deflator for gross domestic product.

We experimented with including additional macroeconomic variables as first-stage instruments. These included the price of investment goods, oil prices, and various interest rates (available from Citibase). We found that including additional variables had little impact on the results. For the reported results, we use the most parsimonious specification, including only lags of investment, cash flow, and a time trend.

There are several reasons why a large number of firms in our industrial file reports data for the 20-year reporting period. The 1989 file begins, thus, with a new wave. We chose our relatively small sample that did not significantly use equipment capital first reported in 1969, and equipment by investment in gross capital number of firms increases in 1969, instead of calculating

We make two significant changes to the user cost of capital. First, we use the Hulten and Wykoff capital stock weights instead, for our user cost required rate of return and total long-term interest to introduce measures of better capturing of increased measures

Firm data were used to estimate the firm's user cost of capital. We set it equal to the estimated interest rate mean for firms in the industry of the capital stock equal to book value

¹⁵ We experimented with using interest rates as measures of the user cost of capital because Compustat reports rates of debt and bond ratings. We did not find that using either measure improved our results.

¹⁶ Estimates of model coefficients are virtually identical results.

There are several data construction issues that merit attention. The number of firms in the panel decreases in 1971. The Compustat Industrial file reports data only for those firms still in existence at the end of the 20-year reporting period. As a result, in 1971, the year in which the 1989 file begins, there are firms included in the old wave but not in the new wave. We chose to retain those firms to avoid deleting data from our relatively small beginning-of-period panels, excluding those firms that did not significantly affect the results. Additional difficulties arise in using equipment data. Data on the gross stock of equipment capital are first reported in 1969. In order to construct the gross stock of equipment capital before 1969, we multiply the firm's gross stock of property, plant, and equipment by its two-digit SIC code, year-by-year share of equipment in gross capital stock as reported by the BEA. As a result, the number of firms reported in the equipment investment models decreases in 1969, the point we begin using data on gross investment instead of calculating it.

We make two significant improvements in the construction of the user cost of capital. First, we construct firm-specific depreciation rates rather than using the one-digit SIC code depreciation rates constructed with Hulten and Wykoff (1981) depreciation data combined with aggregate capital stock weights (see Cummins, Hassett, and Hubbard, 1994a). Second, for our user cost of capital experiments, we construct a firm-specific required rate of return using Compustat data on firms' interest expense and total long-term and short-term debt.¹⁵ These changes necessarily introduce measurement error. Despite this, we believe that the benefits of better capturing firm-specific investment incentives outweigh the cost of increased measurement error.¹⁶

Firm data were deleted or modified according to the following rules. If the estimated firm depreciation rate is negative or greater than unity, we set it equal to the mean for firms in the same four-digit SIC code. If the estimated interest rate is above 25 percent, we also set it equal to the mean for firms in the same four-digit SIC code. If the replacement value of the capital stock or inventory is estimated to be negative, we set it equal to book value. If dividend payouts on preferred stock are reported

¹⁵ We experimented with using Compustat data on the firms' S&P debt rating and bond rating as measures of the real interest rate firms face. We opted to use the method above because Compustat reports those data items only from 1978 onward. We believe the class of debt and bond rating may provide a better measure of a firm's real interest rate but did not find that using either measure in our sample after 1978 significantly improved our results.

¹⁶ Estimates of models with a fixed real required rate of return of 4 percent produced virtually identical results.

as missing, we set them equal to zero. If no inventory valuation method is specified, we assume the firm used the FIFO system. If multiple variation methods are reported, our calculations assume that the primary method is used.

We delete observations if the ratio of investment to the beginning-of-period capital stock is greater than unity. We also delete observations if the ratio of cash flow (or net income) to the beginning-of-period capital stock is greater than 10, in absolute value. These two rules delete observations that represent especially large mergers, extraordinarily firm shocks, or Compustat coding errors. They delete fewer than 5 percent of the firms used in first-stage estimation. Finally, we delete observations whose forecast errors from the first-stage are more than 20 times higher than the mean forecast error. These large forecast errors typically occur when there are very few observations for the firm so that forecasting is very imprecise. Again, these rules usually delete a very small fraction of the data (for about 1 percent of the firms, and never more than 5 percent). The results are not sensitive to which specific cutoff values are used.

REFERENCES

- Abel, Andrew B. (1990). "Consumption and Investment." In B. M. Friedman and F. H. Hahn (eds.). *Handbook of Monetary Economics*, Vol. 2. Amsterdam: North-Holland.
- Altshuler, Rosanne, and Alan J. Auerbach. (1990). "The Significance of Tax Law Asymmetries." *Quarterly Journal of Economics* 105:61-86.
- Auerbach, Alan J. (1986). "The Dynamic Effect of Tax Law Asymmetries." *Review of Economic Studies* 103:205-225.
- . (1989). "Tax Reform and Adjustment Costs: The Impact on Investment and Market Value." *International Economic Review* 30:939-962.
- , and Kevin A. Hassett (1992). "Tax Policy and Business Fixed Investment in the United States." *Journal of Public Economics* 47:141-170.
- , and James M. Poterba (1987). "Tax Loss Carryforwards and Corporate Tax Incentives." In *The Effects of Taxation on Capital Accumulation*, Martin Feldstein (ed.). Chicago: University of Chicago Press.
- Chirinko, Robert S. (1993). "Business Fixed Investment Spending: A Critical Survey of Modeling Strategies, Empirical Results, and Policy Implications." *Journal of Economic Literature* 31:1875-1911.
- Cordes, Joseph J., and Steven M. Sheffrin. (1983). "Estimating the Tax Advantage of Corporate Debt." *Journal of Finance* 38:95-105.
- Cummins, Jason G., Kevin A. Hassett, and R. Glenn Hubbard. (1994a). "A Reconsideration of Investment Behavior Using Tax Reforms as Natural Experiments." *Brookings Papers on Economic Activity* 2:181-249.
- , ———, and ———. (1994b). "Using Tax Reforms to Study Investment Decisions: An International Study." Columbia University. Mimeograph.
- Fazzari, Steven M., R. Glenn Hubbard, and Bruce C. Petersen. (1988). "Financ-

ing Constraint
ity 1:141-195.
Hall, Robert E.,
Behavior." *An*
Hulten, Charles
Depreciation.
Charles R. Hu
Jorgenson, Dale
Economic Review
Summers, Lawr
Approach." *B*

ing Constraints and Corporate Investment." *Brookings Papers on Economic Activity* 1:141-195.

Hall, Robert E., and Dale W. Jorgenson. (1967). "Tax Policy and Investment Behavior." *American Economic Review* 57:391-414.

Hulten, Charles R., and Frank Wykoff. (1981). "The Measurement of Economic Depreciation." In *Depreciation, Inflation, and the Taxation of Income from Capital*, Charles R. Hulten (ed.). Washington, DC: The Urban Institute.

Jorgenson, Dale W. (1963). "Capital Theory and Investment Behavior." *American Economic Review* 53:247-259.

Summers, Lawrence H. (1981). "Taxation and Corporate Investment: A q -Theory Approach." *Brookings Papers on Economic Activity* 1:67-127.